

Indoor Station

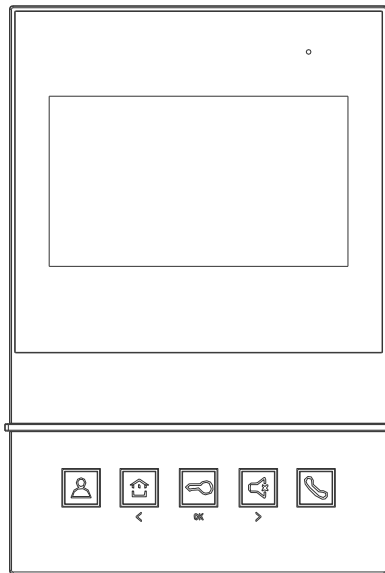

T series 4.3 inch Indoor Station User Manual_V1.0
T-IS04

Attentions

1、 Please keep devices away from strong magnetic field , high temperature , wet environment ;



2、 Please do not fall the devices to the ground or make them get hard impact ;



3、 Please do not use wet cloth or volatile reagent to wipe the devices ;



4、 Please do not disassemble the devices.

Content

Chapter 1 Function in brief	1
Chapter 2 Product Introduction	2
2.1 Product Appearance	2
2.2 Product Dimension	2
2.3 Touch Key Instruction	3
2.4 Interface Description	4
2.5 Parameters	4
Chapter 3 Basic Functions	5
3.1 Stand-By mode	5
3.2 Call in	5
3.3 Calling Guard Unit	6
3.4 Surveillance	6
3.5 Intercom	7
Chapter 4 System Setting	8
4.1 Address Setting	8
4.2 Video Setting	9
Chapter 5 Installation	10
5.1 Installation Height	10
5.2 Installation Illustration	11

Chapter 1 Function in brief

This product is a part of the 2-wire analog video door phone system. The system consist of Power Supply, Outdoor Station, and Indoor Station, each part is connected to the system via 2 core wires. The functions and characteristic of this product are as follows:

- **Support visual intercom, unlock**
- **Support real time surveillance to outdoor station and camera**
- **Support intercom function between residents in the same community**
- **Support intercom function between other indoor stations that are installed in the same house**
- **Support second doorbell**

Chapter 2 Product Introduction

2.1 Product Appearance

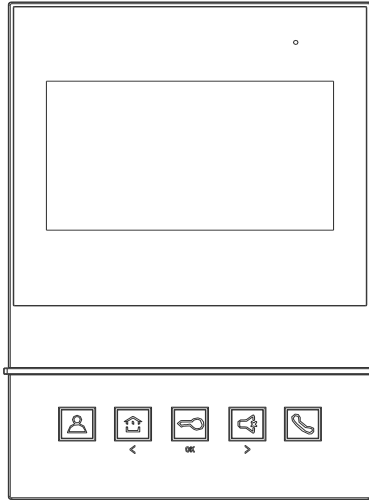

2.2 Product Dimension

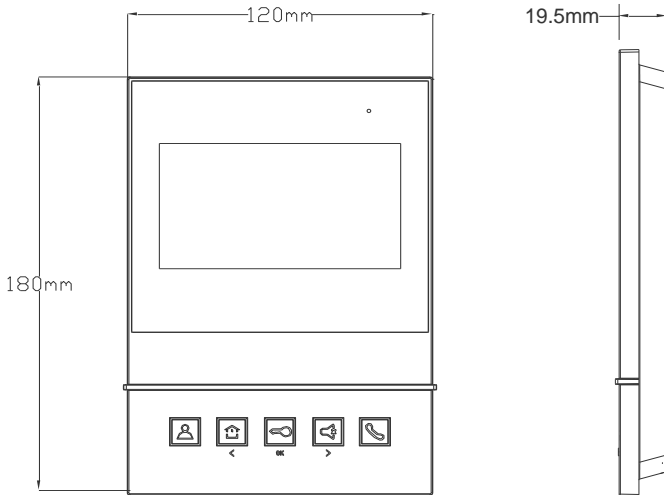

2.3 Touch Key Instruction

Extended Power Supply

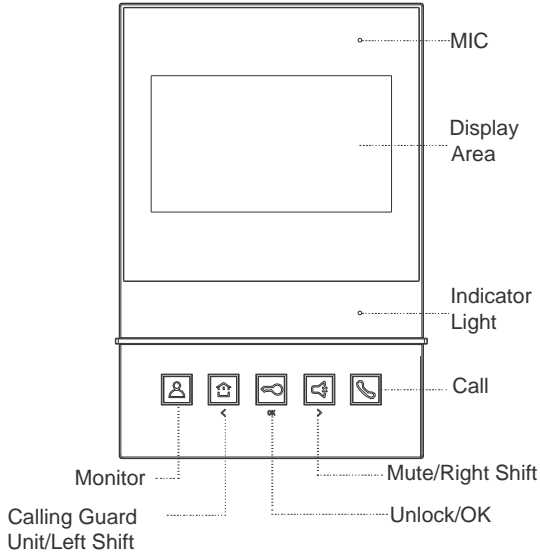

Press the touch keys when the device is under Stand-By mode, each functions are as follows:

Monitor: Enter the monitor of Outdoor Station 1;

Calling Guard Unit / Left Shift: To call Guard Unit (Indoor Station will turn into Guard Unit when device address is 200), Indicator Light flashing if Guard Unit doesn't exist;

Unlock/OK: No response under Stand-By mode;

Mute/Right shift: Short press to turn on/off mute (Indicator light show red when mute). Mute function can synchronize with other Indoor Monitors within the same house. Long press Mute to synchronize;

Call: Press to enter the intercom interface.

Indicator Light:

Green light always on: Power on

Green light flash: Incoming call

Red light: Mute

2.4 Interface Description

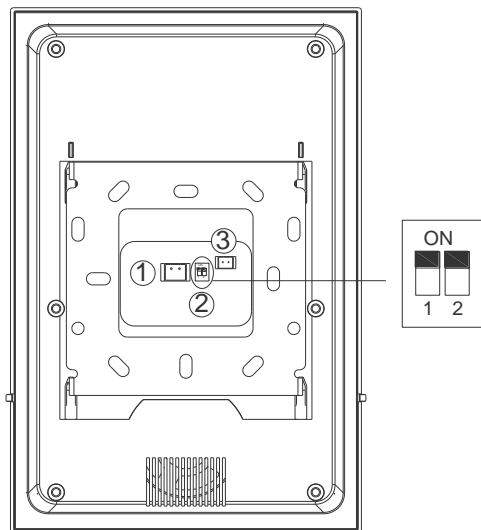

Number ① Bus port.

Number ②

1: Master/Slave device Setting, turn on to be Master device

2: Impedance Matching, turn on when installing the last Indoor Station. While using Distributor, all Indoor Stations' impedance matching should turn off.

Number ③ Doorbell port.

2.5 Parameters

Working Voltage : DC 24 ~ 32V

Quiescent Current : ≤ 10 mA (DC 30V)

Working Current : ≤ 170 mA (DC 30V)

LCD Display : 4.3 inch

Resolution : 480×272

Outline Dimension(L×W×D): 180×120×19.5 mm



Working Temperature : -10°C ~ +55°C

Storage Temperature : -25°C ~ +70°C

Chapter 3 Basic Functions

3.1 Stand-By mode

LCD Display turn off when the device is under Stand-By mode, and the Indicator Light always on.

1. Under Stand-By mode, long press  for 3s to set the device address.
2. Under Stand-By mode, short press  to execute customize function(able to call other Indoor Stations that are installed in the same house, call Guard Unit, Unlock 2 etc) .
3. Under Stand-By mode, short press Call key to enter the intercom interface.
4. Under Stand-By mode, short press Mute key to mute the current device, if long press Mute key for 3s, mute state will be synchronize to other Indoor Stations that are installed in the same house.(Indicator Light turn red while device is under mute state)
5. Under Stand-By mode,short press monitor key to monitor Outdoor Station,



3.2 Call in

Basic workflow: Ring bell \rightleftarrows **Call** \rightleftarrows **Unlock** \rightleftarrows **Call ended**



Interface of bell rings

Incoming Call:

1. Visitor can call indoor monitor from outdoor station, the bell of indoor monitor rings.
2. Resident can press  to answer the call.
3. During the talking, resident can press  to unlock the gate/door, after

unlocking for 5s the call will be ended automatically.

4. Resident can press  again to end up phone call.

3.3 Calling Guard Unit

Basic workflow: Ring bell \Rightarrow Call \Rightarrow Unlock \Rightarrow Call ended





Interface of Calling Guard Unit



While Indoor monitor is under Stand-By mode, resident can press  to call the Guard Unit.

3.4 Surveillance

Basic workflow: choose monitoring facility \Rightarrow Monitoring \Rightarrow Unlock \Rightarrow Monitoring completed

1. Press  to monitor Outdoor Station, if the resident have installed multiple Outdoor Station, press  again will switch to the next camera.

2. During monitoring, resident can press  to unlock the gate/door for visitor.







3. During monitoring, press  to call the monitoring device, press  again to end up phone call.

3.5 Intercom

Under Stand-By mode, short press  to enter Intercom interface:



Address setting interface

1. In the intercom interface. Short press  to increase the address number.
 Long press , the address increase rapidly (cycle from 001 - 200). Short press  to decrease the address number. Long press  the address decrease rapidly.
2. In the Intercom interface, short press  to make a call and the device begin to play the ringback tone;
3. In the Intercom interface, short press  to exit to standby mode.







Chapter 4 System Setting

4.1 Address Setting

While under Stand-By mode, long press  for 3s to enter Address Setting interface.



Interface of Address Setting







1. Short press  address number add 1 digit. Long press  address number increase rapidly(circulating from 200 to 001)
2. Short press , current address number will be saved and the device will enter Stand-By mode again.
3. Short press  address number minus 1 digit. Long press  address number decrease rapidly(circulating from 200 to 001)
4. Short press  quit to Stand-By mode without saving current address number.

4.2 Video Setting

While the device is in the state of ringing / surveillance / calling, press  , the Video Setting menu will shows up:



Interface of Video Setting

1. Press  or  to choose the setting of BRHTNESS, CONTRAST and COLOR.
2. After choosing, press  to enter the further setting(BRHTNESS, CONTRAST, COLOR), then press  and  to adjust the specific parameter, Range: 0-10.
3. Press  to get back in ringing / surveillance / calling state, and the setting menu will disappear.
4. The OSD menu will disappear automatically and the device will get back in monitor state if there's no operations in 5s.

Chapter 5 Installation

5.1 Installation Height

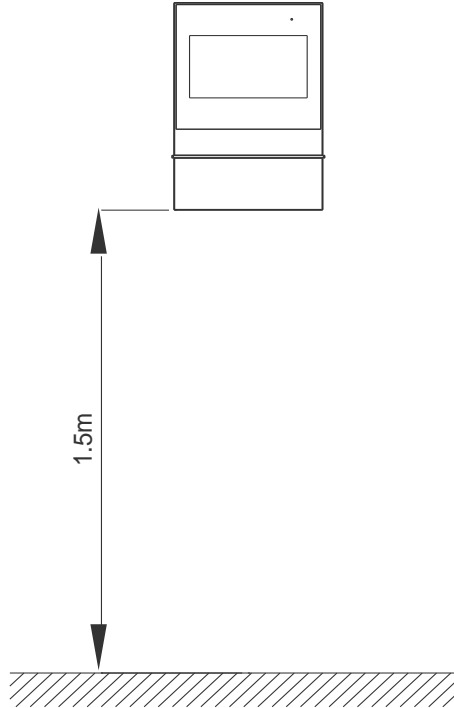

Recommended height: 1.5 m

Remark: When this product is affected by interference signal which is $\geq 3V/m$ and in range of 3.4MHz~63MHz, there will be interference phenomenon of diagonal strip appearing on video image (Please avoid external interference when assembling).

5.2 Installation Illustration

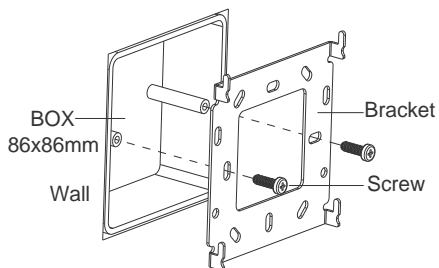

Step 1:

Drive the screws on the bracket with the holes on the 86 box.

Fasten the screws to fix the bracket

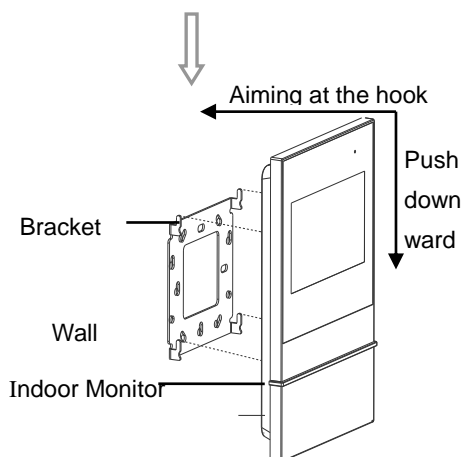

Step 2:

After finishing the wiring of the indoor station, aim the slot behind the indoor station to the hook of the bracket(②).

After aiming correctly, move downward a little to make the indoor station well fastened on bracket.(③)

Finish installation(④)

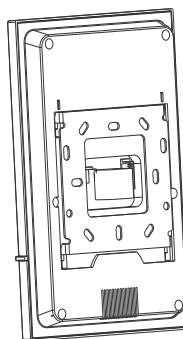
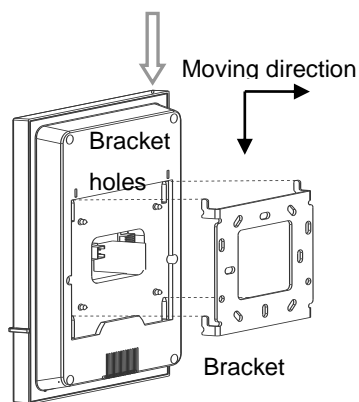

With the bracket installed

